

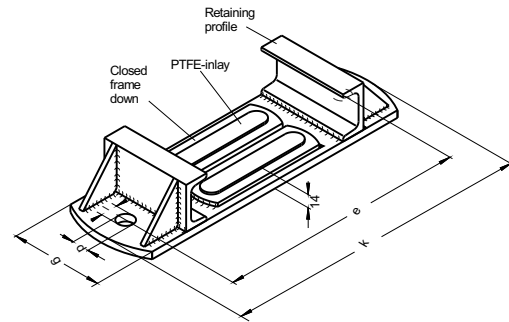



SCREW ON GLIDE PLATE

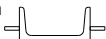

Type **302 SH**
302 A-SH

dipa

Fig. Type 302 SH
Size 7

All dimensions in mm

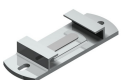
Selection list for glide support Type 180 H, 180 VAH and Type 171-1H, 171-1 VAH, 171-2H, 171-2 VAH									
Profile form bearing 									
Design	Size	Pipe \varnothing	e	g	k	l	d	Item number hot-dip galvanized	Permissible load to bear on [kg]
	1	21,3 - 48,3	148	60	193	26	13	25004696	800
	2	57,0 - 60,3	158	60	203	26	13	25004697	800
	3	70,0 - 88,9	168	60	213	26	13	25004698	800
	4	108,0 - 139,7	188	80	233	26	13	25004699	1200
	5	159,0 - 168,3	215	80	267	26	18	25004700	1500
	6	219,1 - 273,0	235	80	287	26	18	25004701	1800
	7	323,9 - 457,0	275	100	337	31	22	25004702	1800
	8	508,0	318	100	380	31	22	25004703	2600
	9	610,0	358	100	420	31	22	25006566	2800
	10	711,0	418	100	480	31	22	25011869	2800
	11	813,10 - 914,0	528	100	590	-	23	25023316	2800

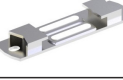
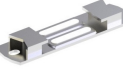
Selection list for glide support with sound insulation Type 180 AH and Type 171-1AH, 171-2 AH									
Profile form bearing 									
Design	Size	Pipe \varnothing	e	g	k	l	d	Item number hot-dip galvanized	Permissible load to bear on [kg]
	1	21,3 - 48,3	148	60	193	26	13	25024963	800
	2	57,0 - 60,3	158	60	203	26	13	25024964	800
	3	70,0 - 88,9	168	60	213	26	13	25024965	800
	4	108,0 - 139,7	188	80	233	26	13	25024966	1200
	5	159,0 - 168,3	215	80	267	26	18	25024667	1500
	6	219,1 - 273,0	235	100	287	26	18	25024968	1800
	7	323,9 - 457,0	318	100	380	31	22	25024969	1800
	8	508,0	358	100	420	31	22	25030782	2600

Ordering designation: Type...
e.g. 302 SHSize...
Size 5Surface...
hot-dip galvanizedItem number
25004700