

**ROHRHALTERUNG****Typ 116 hv-D**

höhenverstellbar für Schellen Typ DIN 3567 A

dipa

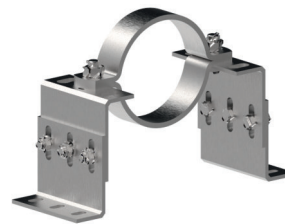
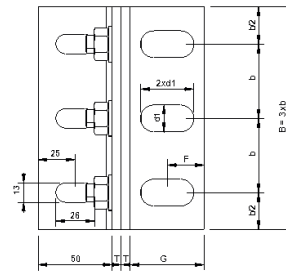
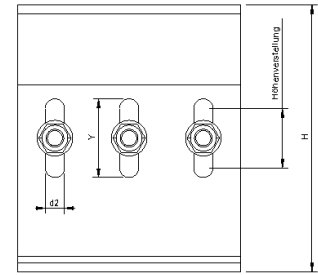
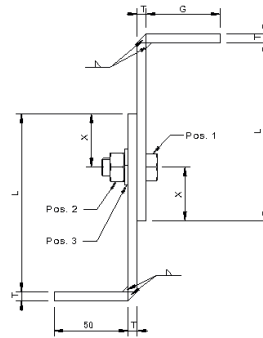
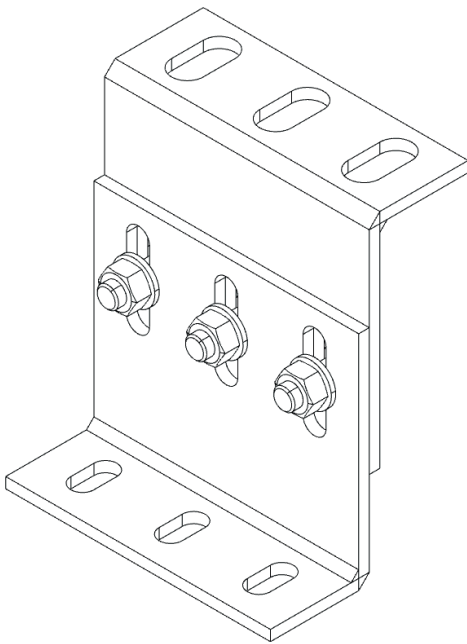

Festpunkt:  
2 x Typ 116 hv  
mit 1 Stück  
Typ DIN 3567 A

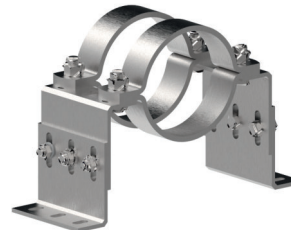

Festpunkt:  
2 x Typ 116 hv  
mit 2 Stück  
Typ DIN 3567 A

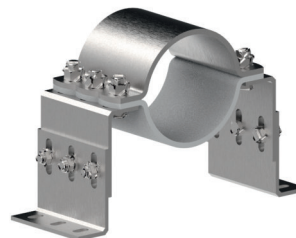

Festpunkt:  
2 x Typ 116 hv  
mit 3 Stück  
Typ DIN 3567 A

für Ø	20-49	57-89	108-220	267-368	407-521	610
b	30	40	50	60	80	100
B	90	120	150	180	240	300
d1	11.5	14.0	18.0	23.0	27.0	
d2	11.5		13.0	13.0	16.0	23.0
F	14	18	25	30	40	50
G	40		50	60	80	100
H	95-145		140-220	180-280	250-350	320-460
Höhen- verstellung	± 25		± 40	± 50		± 70
L	80		120	160	200	250
Pos. 1 Schraube DIN 933	M 10 x 30		M 12 x 40		M 16 x 40	M 20 x 40
Pos. 2 Mutter DIN 934	M 10		M 12	M 16	M 20	
Pos. 3 U-Scheibe DIN 125	M 10		M 12	M 16	M 20	
T	6			8		
X	26		36	53	58	60
Y	37		53	63	68	93

Typ 116 hv passend für

- 1 Stück Typ 3567 A mittig
- 2 Stück Typ 3567 A links und rechts
- 3 Stück Typ 3567 A

**Lieferform**

Stahl Wst.-Nr. 1.0038 in schwarz oder verzinkt  
bzw. Edelstahl Wst.-Nr. 1.4301 oder 1.4571  
bzw. beschichtet